

작업공정사진철

고객명: (주)

공사명: YE-056 PRESS PUMP MOTOR

규격: AC MOTOR 1260HP 6P 3300V

REPAIR 내역: 분해 조립 및 조립부품 불순물 CLEANSING
INSULATING VARNISH DIPPING DRYING
양측 HOUSING METALLIZING 연마
BALANCING 및 UNBALANCE교정
BEARING 교환
입 출고검사 시운전 TEST 및 COLOR PAINTING



<http://jinyangmotor.com/>



JIN YANG

작업 공정 사진

작업공정

AC MOTOR 1260HP 6P 입고검사



Ass'y

분해 전

작업공정

AC MOTOR 1260HP 6P 입고검사



권선검사

절연저항 & 각 상별 권선저항

JIN YANG

작업 공정 사진

작업공정

AC MOTOR 1260HP 6P 입고검사



냉각 통풍구

분진으로 많이 막힘

작업공정

AC MOTOR 1260HP 6P 입고검사



분해전

냉각 통풍구 청소실시

JIN YANG	작업 공정 사진
작업공정	AC MOTOR 1260HP 6P 입고검사
	
분해전	냉각 통풍구 청소 및 세척실시
작업공정	AC MOTOR 1260HP 6P 입고검사
	
분해실시	GREASE CHARGING주기가 너무길어 GREASE가 말라 굳어져 원활작용 상실상태

JIN YANG

작업 공정 사진

작업공정

AC MOTOR 1260HP 6P 입고검사

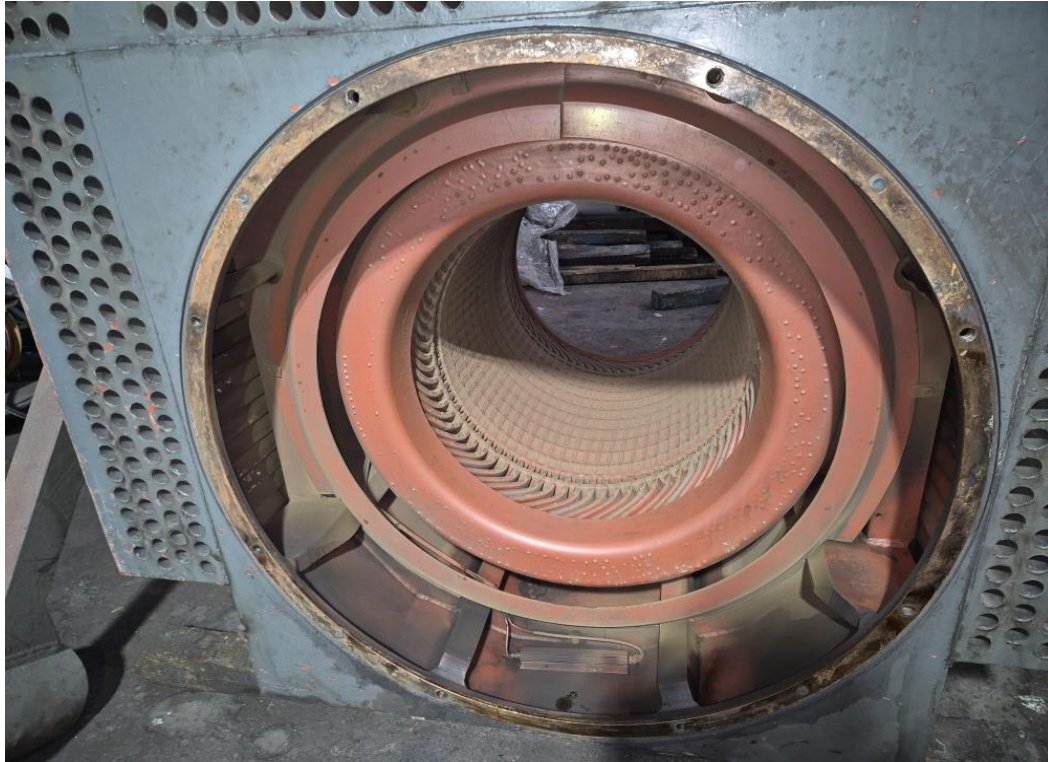

STATOR 권체

분진 흡입은 있으나 권선상태 양호

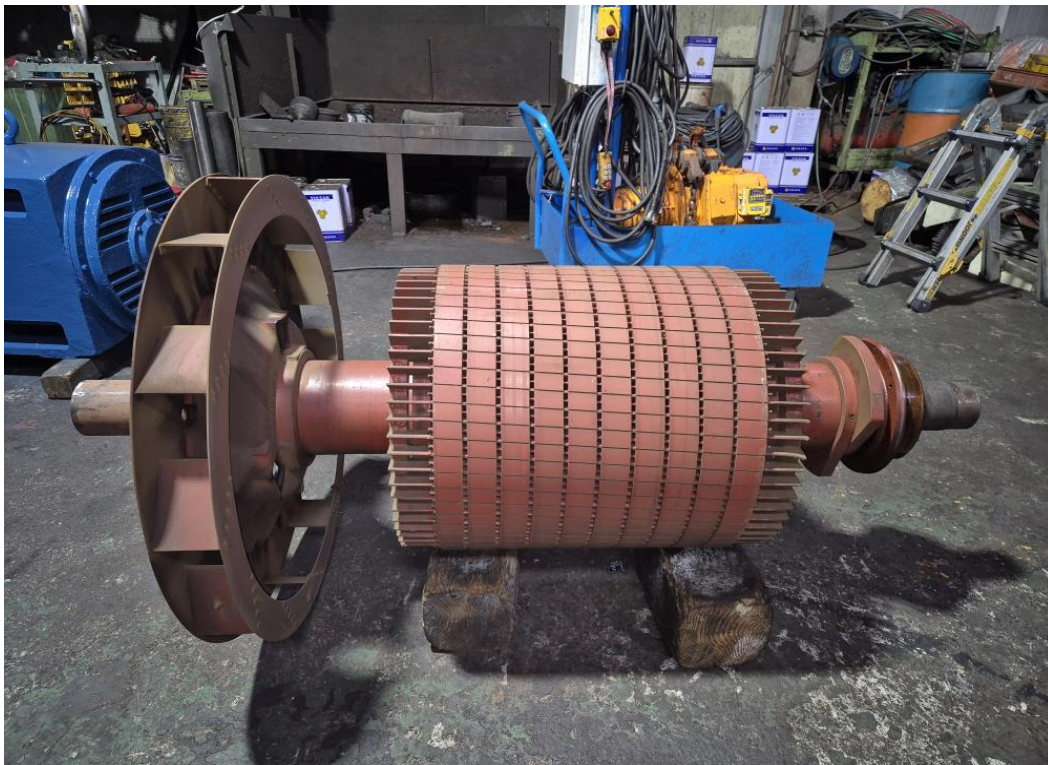

작업공정

AC MOTOR 1260HP 6P 입고검사



ROTOR

분해 후 ROTOR BAR상태 등 양호

JIN YANG	작업 공정 사진
작업공정	AC MOTOR 1260HP 6P 입고검사
	
BRACKET	부하측 HOUSING검사 측정치 5.5/100로 마모불량
작업공정	AC MOTOR 1260HP 6P 입고검사
	
BRACKET	반 부하측 HOUSING검사 측정치 5/100로 마모불량

JIN YANG	작업 공정 사진
작업공정	AC MOTOR 1260HP 6P 입고검사
	
ROTOR 및 권체	AIR청소 및 분진제거 실시
작업공정	AC MOTOR 1260HP 6P OVERHAUL
	
STATOR 권체	외부 세척 실시

JIN YANG

작업 공정 사진

작업공정

AC MOTOR 1260HP 6P OVERHAUL

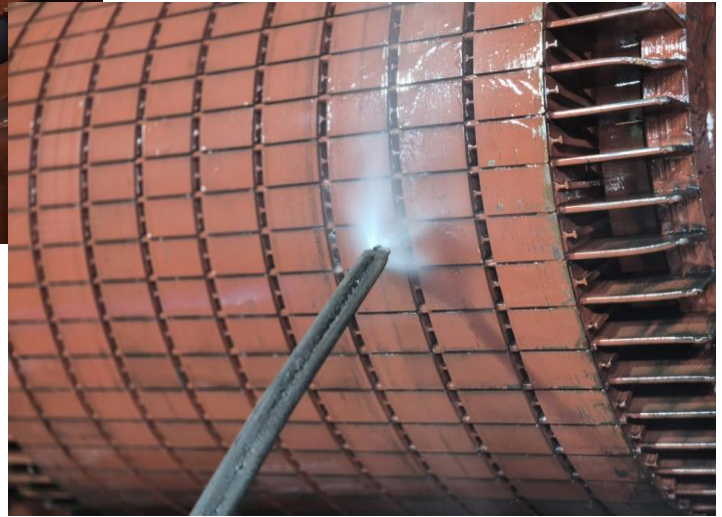

권체

STATOR & ROTOR 세척 실시

작업공정

AC MOTOR 1260HP 6P OVERHAUL



STATOR 권체

세척 후 건조실시

JIN YANG

작업 공정 사진

작업공정

AC MOTOR 1260HP 6P OVERHAUL



조립부품

세척 실시

작업공정

AC MOTOR 1260HP 6P OVERHAUL



ROTOR

BALANCING 실시 및 잔류 UNBALANCE REPORT 참조

JIN YANG	작업 공정 사진
----------	----------

작업공정	AC MOTOR 1260HP 6P OVERHAUL
------	-----------------------------

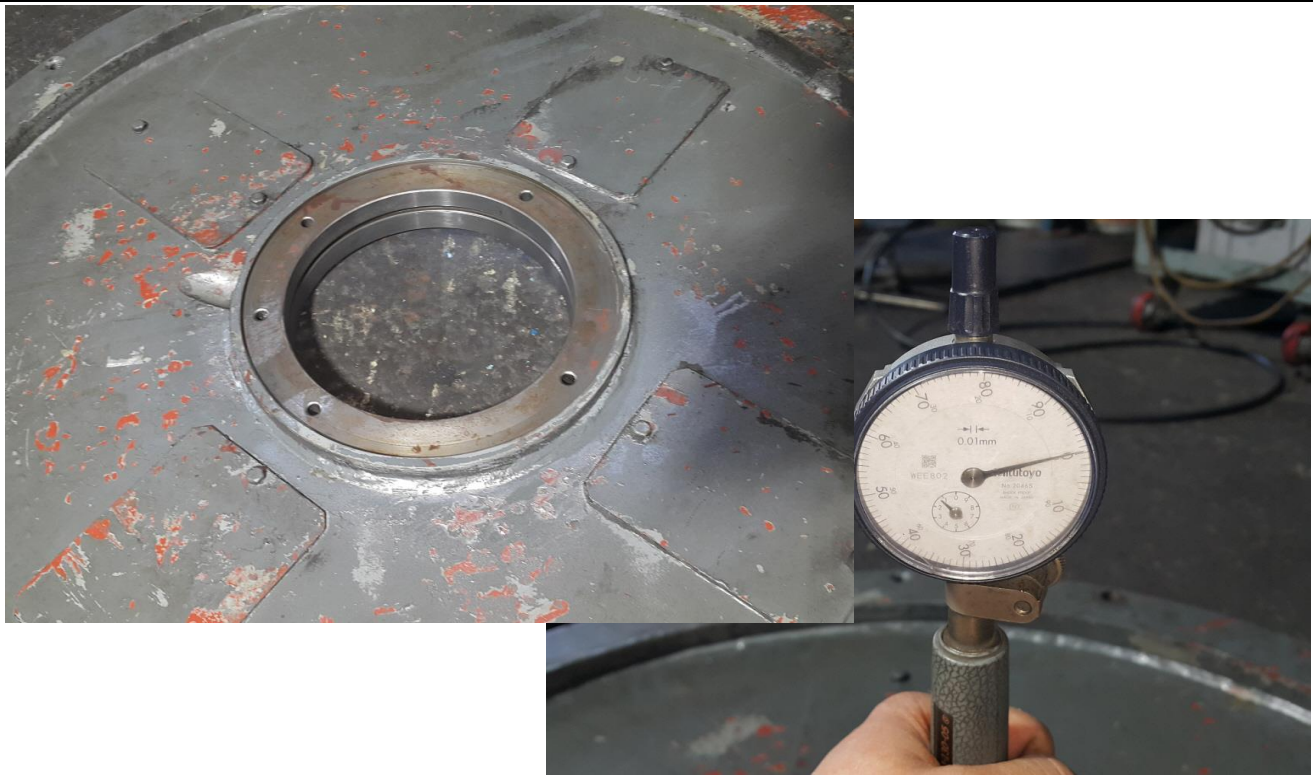

BRACKET	부하측 HOUSING METALLIZING 연마 후 검사 0/100으로 양호
---------	--

작업공정	AC MOTOR 1260HP 6P OVERHAUL
------	-----------------------------



BRACKET	반 부하측 HOUSING METALLIZING 연마 후 검사 0/100으로 양호
---------	--

JIN YANG

작업 공정 사진

작업공정

AC MOTOR 1260HP 6P OVERHAUL

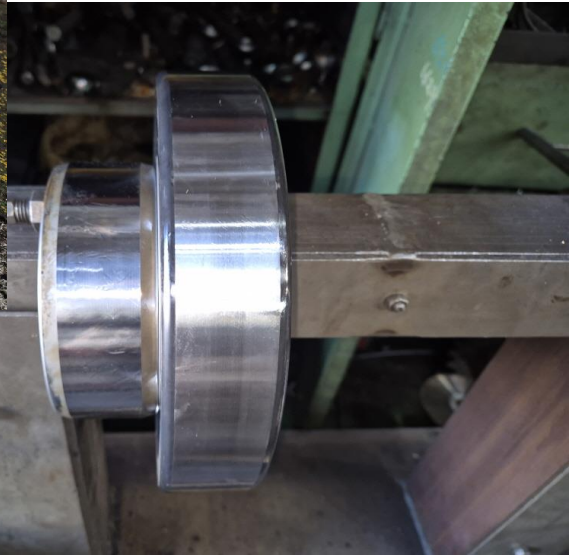

소모품

교환될 BEARING 예열 실시

작업공정

AC MOTOR 1260HP 6P OVERHAUL



조립실시

BEARING 예열교환 및 GREASE CHARGING

JIN YANG

작업 공정 사진

작업공정

AC MOTOR 1260HP 6P OVERHAUL



출고검사

절연저항 & 각 상별 권선저항

작업공정

AC MOTOR 1260HP 6P OVERHAUL

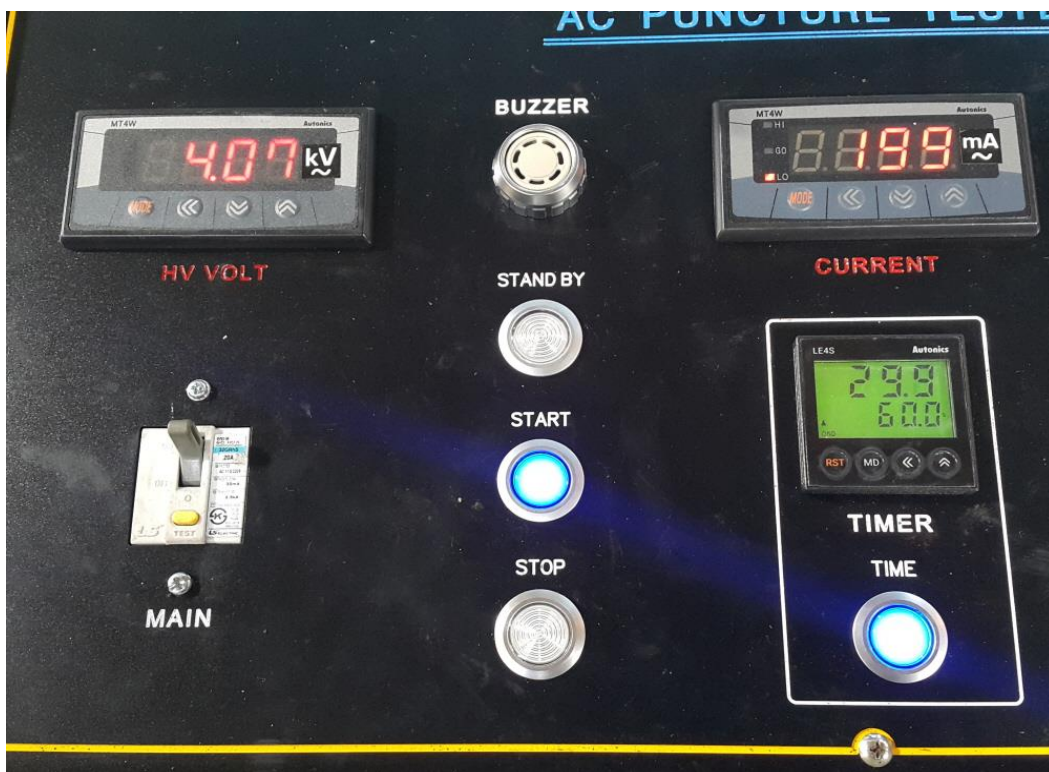

출고검사

절연내력 시험

JIN YANG

작업 공정 사진

작업공정

AC MOTOR 1260HP 6P OVERHAUL



출고검사

시운전 TEST 실시

작업공정

AC MOTOR 1260HP 6P OVERHAUL

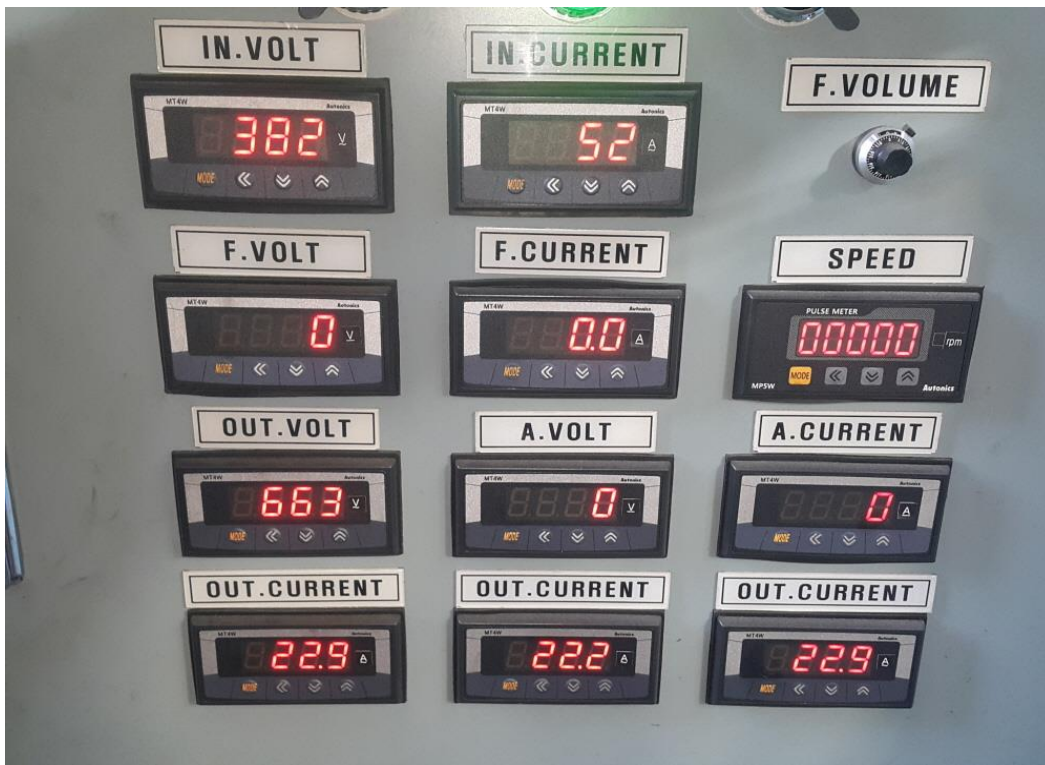

출고검사 후

시운전 TEST 실시 운전 CURRENT

당사 전력 사정으로 660V로 RUNNING TEST만 실시

JIN YANG

작업 공정 사진

작업공정

AC MOTOR 1260HP 6P OVERHAUL



출고검사 후

COLOR PAINTING

작업공정

AC MOTOR 1260HP 6P OVERHAUL

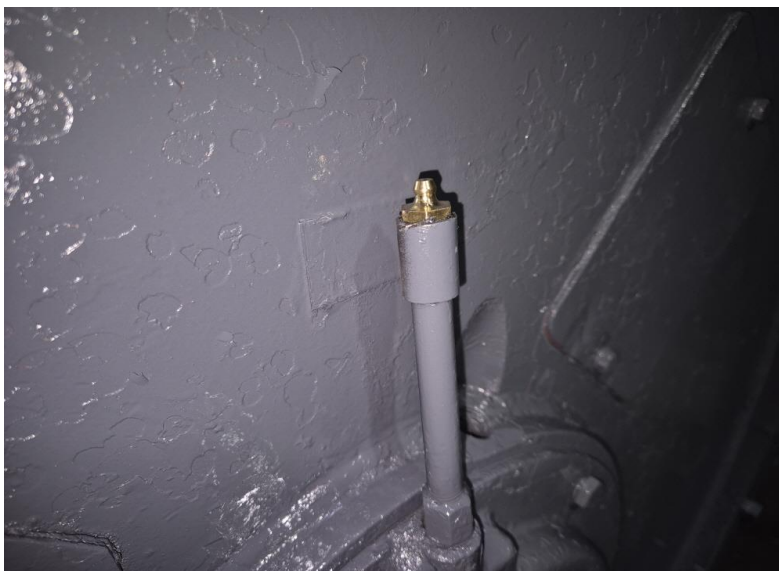

출고검사 후

GREASE CHARGING을 1000시간 주기마다 약100g씩 꼭 하십시오

BALANCING INSPECTION REPORT

SETUP

PROJECT NO: PRESS PUMP MOTOR	
CUSTOMER :	
NO	: 0
TYPE	: 0
OPERATOR	: 0
PART NAME : AC ROTOR	TEST TIME : 2025.11.19 08:00:23
GRADE : G6.3	RATING SPEED : 1200 rpm
WEIGHT : 1484.000 kg	TESTING SPEED : 433 rpm
RADIUS : 425 mm 425 mm	CORRECTION : ADD
ACCEPTABLE UNBALANCE(Unit:g)	
PLANE1 : 87.500	PLANE2 : 87.500

INITIAL UNBALANCE

	PLANE1	PLANE2
UNBALANCE	49.100 g	30.800 g
ANGLE	268 deg	104 deg
RESULT	OK	OK

CORRECT UNBALANCE

	PLANE1	PLANE2
UNBALANCE	49.100 g	30.800 g
ANGLE	268 deg	104 deg
RESULT	OK	OK

CORRECT UNBALANCE GRAPH(max = 50.0 g)

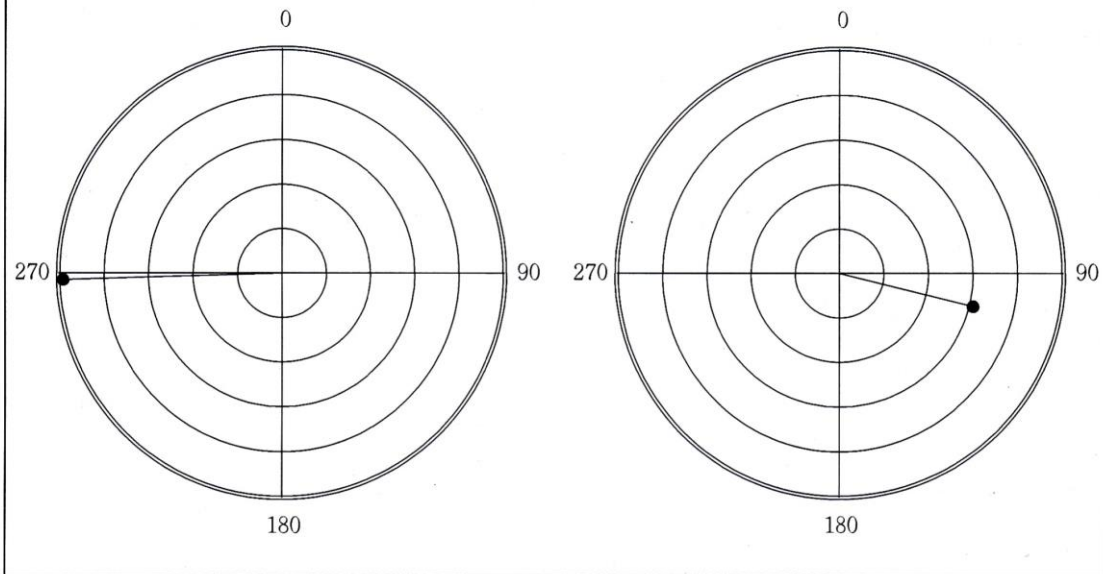

진양전기
 경남 창원시 마산회원구 내서읍 중리공단로3길 17-2
 TEL : 055-231-9318 FAX : 055-231-9314
 E-mail : jinyang2913@naver.com